

HF5 TRANSMITTER



BENEFITS

- Measures relative humidity, temperature and dew point
- Absolute repeatability guaranteed
- Freely programmable and scalable analog outputs

APPLICATIONS

- Heating, ventilation, air conditioning
- Food industry
- Pharmaceutical industry
- Printing and paper industries



Proven housing

- Robust, industrial-quality housing
- Wall or duct mounting possible

Power supply

- 15...40 VDC/12...28 VAC
- 9...36 VDC/7...24 VAC (galvanically isolated)
- 100...240 VAC (galvanically isolated)
- Power over Ethernet (PoE)

Outputs

- The 2 analog outputs are freely selectable and scalable
- **2-wire** (HF52), **3/4-wire** (HF53) and 3/4-wire (HF54, HF56 with galvanic isolation) versions available
- Optional digital outputs allow networking via RS-485, Ethernet and even wireless
- Combined digital and analog output signals allow simultaneous control and monitoring of a device by just one transmitter

Flexible choice of probes

- Connection of a wide range of probes possible
- Connection of simulators facilitates process validation



APPLICATIONS

HF5 WALL VERSION

Use in technical rooms

HF52/53/54 series



HC2A-S

HF53S/54S series



HCA-SM

HF56 series



HC2A-S

HF5 DUCT VERSION

Use in ventilation shafts



PROBES FOR HYGROFLEX TRANSMITTERS

STANDARD CLIMATIC PROBE

Range of application: - 50...100 °C
Variants: Plastic and stainless-steel versions



INDUSTRIAL PROBES

Range of application: - 100...200 °C
Material: Stainless steel



Order Code	Type	Accuracy @ 23 °C	Application Range	Sensor Element	Long-Term Stability
HC2A-IC	Industrial probe	±0.8 %RH ±0.1 K	-100...200 °C	HYGROMER HT-1	<1 %RH / year
HC2A-S	Standard probe, black				
HC2A-S3	Meteo probe, white				
HC2A-SM	Steel probe	±1.2 %RH ±0.1 K	-50...100 °C 0...100 %RH	HYGROMER HH-1	
HC2A-S-HH	Standard probes for harsh environments				
HC2A-SM-HH					

TECHNICAL INFORMATION

HF52/53/54 series

Wall version (W)

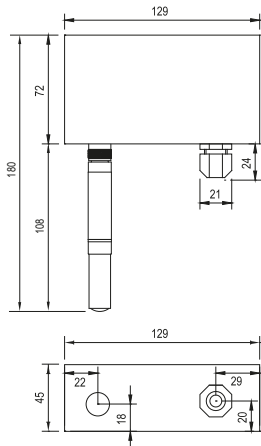

Duct version (D)

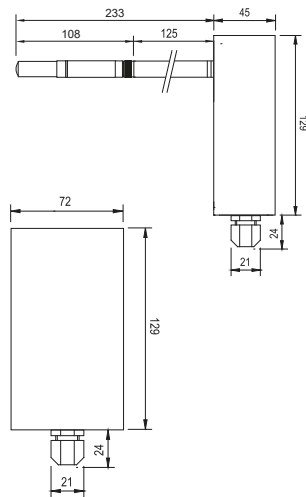

HF56 series

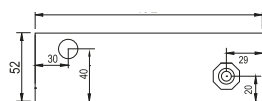
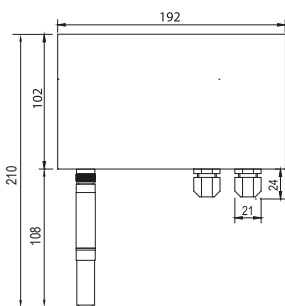

HF53S/54S series

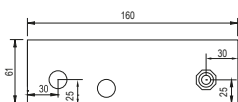
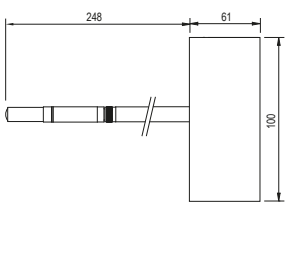
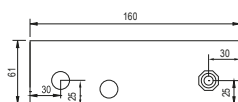
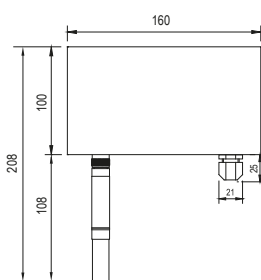

	HF52 2-wire	HF53/54/56 3/4-wire
Humidity probe	HygroClip2 probes, various types*	
Probe cable extension	Passive: max. 5 m, active: 100 m	
Accuracy at 23 ±5 °C	Probe dependent	
Response time τ 63	Probe dependent	
Initialization time	HF53/54/56 typically 3 s, HF52 typically 60 s	
Measurement range	Probe dependent	
Range of application electronics	HF53/54/56: -40...60 °C / 0...100%RH (-10...60 °C with LCD)	
Display type (option) (HF52: without backlight)	Graphic with backlight Display freely configurable	
Trend indicator	Yes	
Output signals (analog)	Freely scalable by user 0...1 V, 0...5 V, 0...10 V, 0(4)...20 mA	
Digital outputs (optional)	Ethernet (LAN, WLAN), USB, RS-485	
Power supply	HF52: 10...28 VDC: 10 V + (0.02 x load) HF53: 15...40 VDC/12...28 VAC HF54 with galvanic isolation: 9...36 VDC HF56 with galvanic isolation: 100...240 VAC	
Current consumption	HF52: max. 40 mA, others <100 mA, LAN option <300 mA	
Circuit type	HF52: 2 x 2 wires HF53/54/56: 3/4 wires	
Load per analog output	V-signal: ≥1 kΩ/V / mA-signal: ≤500 Ω	
Load compensation	Yes	
Firmware upgradable	Yes, via HW4 software	
Sensor diagnostics (drift, state)	Programmable. Default: Off	
Humidity adjustment	Keyboard/Software: multipoint (HF53/54/56)	
Temperature adjustment	Keyboard: 1-point Software: 2-point (HF53/54/56)	
External memory function for logging	Yes, 2000 data point memory	
Psychrometric calculations	All	
PC interface, UART	Yes, HW4-compatible	
Data processing via HW4	Graphics, statistics, analyses, qualification, etc.	
Housing material	ABS / Aluminum (HF5xxS)	
Cable connections	1 x M16 x 1.5, to terminals	
Standards	CE conformity 2014/30/EU	
Audit trail, electronic records	Conforms to FDA 21 CFR Part 11 and GAMP	
IP protection & fire protection class	IP65 / Corresponds to UL94-HB	

* HF520 transmitters are not compatible with metal industrial probes

Subject to technical change without notice. Printing and other errors reserved.

59086E/2019-12

ORDER CODE

Power supply and output signal type										
Supply voltage	Type	Output								
<i>2-wire (only display without backlight, digital interface not possible)</i>										
10...28 VDC	2-wire	4...20 mA	HF520-							
Low voltage, 3-wire										
18...40 VDC / 13...28 VAC	3-wire	4...20 mA	HF532-							
18...40 VDC / 13...28 VAC	3-wire	0...10 V	HF535-							
Low voltage, 4-wire, galvanically isolated										
9...36 VDC / 7...24 VAC	4-wire	4...20 mA	HF545-							
High voltage, 4-wire, galvanically isolated (in HF8 housing)										
100...240 VAC	4-wire	4...20 mA	HF565-	W						
Device type / Mechanical installation										
Duct probe, probe length Ø 15 x 208 mm									D	
Wall probe, probe length Ø 15 x 85 mm									W	
Output parameters										
Humidity & temperature (humidity always 0...100 %RH)									B	X X
Humidity & specific humidity (Q) in g/kg									4	X X
Humidity & mixing ratio (R) in g/kg									6	X X
Temperature & dew point									A	
Temperature & wet-bulb temperature (Tw) in °C									C	
Temperature & enthalpy (H) in kJ/kg									D	
Temperature & specific humidity (Q) in g/kg									E	
Temperature & mixing ratio (R) in g/kg									G	
Output scaling of temperature (humidity always 0...100 %RH)										
No temperature output									X	X
0...50 °C									1	X
0...100 °C									A	3
0...150 °C									D	6
-40...60 °C									3	X
-30...70 °C									4	X
-40...85 °C									5	X
0...100 °C									6	X
Optional display										
Display (only for horizontal mounting)										D
No display (vertical mounting always without display)										X
Electrical connections / Interface configuration / Mounting type										
Cable gland	Mounting	Display								
Analog signals to terminal										
1x M16 / 2x M16 in HF56x	Horizontal	Possible								1
1x M16	Vertical	Not possible			D					X 2
Analog and feed signal to terminal										
Tuchel T7 connector, direct	Horizontal	Possible	HF53x							F
			HF54x							
RS485 to terminal & analog signal to terminal										
2x M16	Horizontal	Possible	HF53x							H
			HF54x							
			HF562							
Ethernet RJ45 & RS485 to terminal & analog signal to terminal										
1x M16 / 2x M16 in HF56x	Horizontal	Possible	HF53x							L
			HF54x							
			HF562							
Scaling of calculated parameters										
No calculation										X X
0...20										1 X
0...25										2 X
0...50										3 X
0...100										4 X
-50...200										D X